

Uniclass L5:P7113			
CI/SfB	(4-)	Hn7	11 .24

Swish[®]
BUILDING PRODUCTS



Range Guide

Design Options for PVC

- Roofline
- Dry Verge
- Cladding
- Rainwater



FS 681825



EMS 681826



OHS 690332



ENMS 620926



CLADDING CERTIFICATE No 91/2622
ROOFLINE CERTIFICATE No 91/2620



BS 7619

Licence No. KM33730



BS 7619

Licence No. KM508760



Responsible Sourcing

www.greenbooklive.com

The Specifier's Choice for Cellular PVC Roofline & Cladding

About Swish

- The premier brand in cellular PVC roofline and cladding
- Most comprehensive system available
- Over 40 years experience in plastics technology
- Non-lead formulation complies with UK, EEC and PVC Industry guidance on removal of lead from PVC
- Non-lead formulation will not discolour
- 20 Year Product Guarantee on White cellular PVC and 10 Years on Coloured and Foiled profiles
- Technical Services team focus on specifier requirements, providing comprehensive support.
- BBA on white cellular PVC profiles
- BSI certification (Kitemarked)
- Swish has obtained the responsible sourcing certification BES6001 for all its cellular PVC products
- National network of Specialist stockists ensures expert local support



Swish Fascias and Bargeboards

White

Swish Jumbo™ boards are strong, load bearing profiles. These boards are secured directly to the rafter foot and fully support the weight of eaves tiles and rainwater systems. A wide range of sizes ensures specifier requirements are met. Soffit boards are available in the form of vented and unvented flat boards and interlocking cladding profiles. A fluted (unvented) board is also available.



Foiled

Swish 16mm fascia and 9mm vented and unvented soffit boards match most window and conservatory systems currently in use. Each foiled finish is accompanied by a full complement of colour matched corners, joints and trims. Swish cladding profiles are also available in foiled finishes (see page 11).

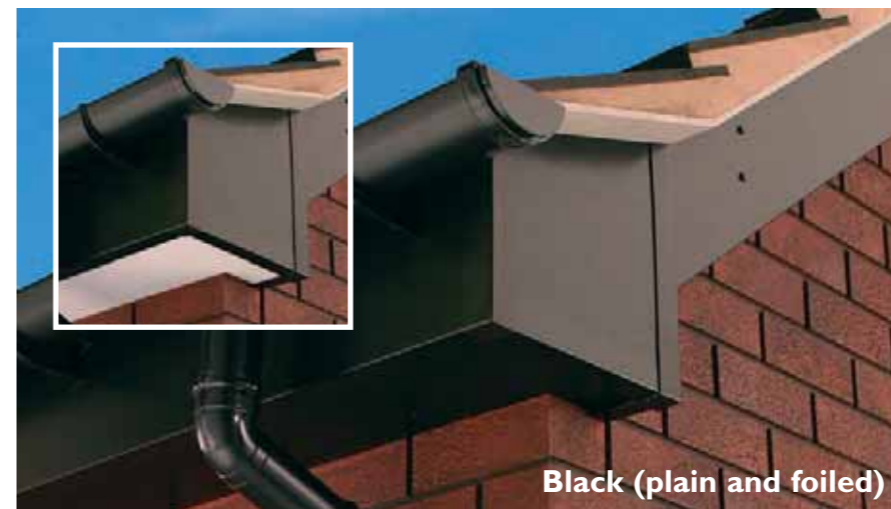
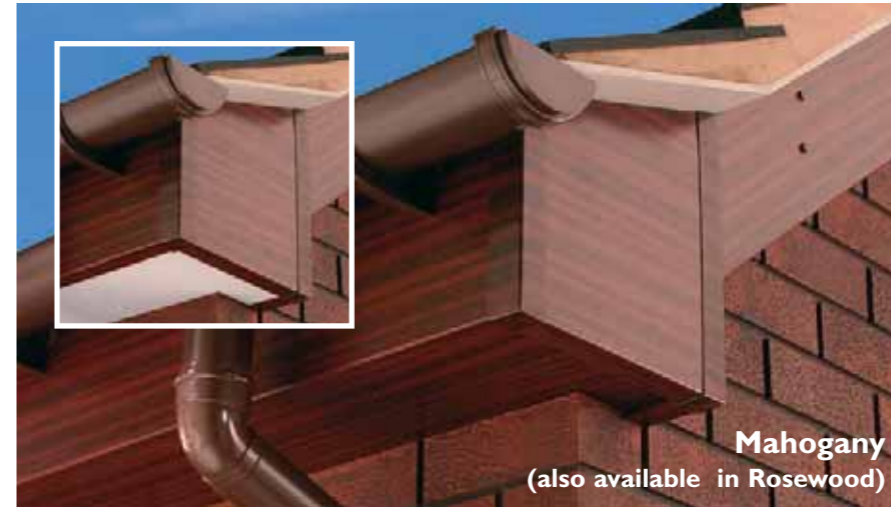

Sustainability

Cellular PVC suits the exposed conditions on clad facades and at the roofline, especially as these areas are difficult and costly to access and maintain.

Swish cellular PVC requires no maintenance; it will last the life-time of the building and can be fully recycled at the end of its service life.

Swish cellular PVC offers the potential of a 60+ year, maintenance-free working life, minimising maintenance costs for landlords and home owners alike. This low lifetime cost may free up maintenance budgets for the purchase of other CO₂ reduction materials such as loft insulation.

At the end of their working life, Swish profiles can be easily removed and recycled.

Colour Options

Swish 16mm Square Fascias and 9mm flat Gee Pee™ soffit boards are also available in a range of co-extruded and foiled finishes.

Co-extruded

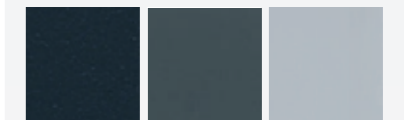

Black (A) RAL 9011 Anthracite Grey (G) RAL 7016 Light Grey (E) Nearest RAL 7040

Foiled



Mahogany (M) RAL 8016 Light Oak (C) RAL 8007 Rosewood (R) RAL 8016 Irish Oak (Q)



Black (Z) RAL 8022 Anthracite Grey (X) RAL 7016 White (K) RAL 9010 Cream (D) RAL 9001

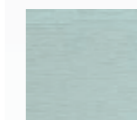

Agate Grey (AG) RAL 7038

Note: The above swatches are not an accurate representation of colour* therefore it is recommended that a sample be requested to aid colour matching.

* For colour availability in specific board styles and sizes please refer to the latest copy of the Swish Price List.

Verge Master

The Verge Master system has been designed to offer a superior looking, solid, secure and professional dry fix verge solution. The robust, well engineered system delivers a dependable quality installation every time.



The system is available in grey, brown and black and manufactured from UV stable high quality polypropylene. Handed units provide superior aesthetics with sleek, stylish lines that add value and kerb appeal.

Installation is quick and easy via the 'flex and clip' installation method and no special tools are required. Verge Master has been independently tested by the BBA and conforms to BS 8612: Dry fixed ridge, hip and verge systems for slating and tiling, in addition to BS 5534 and NHBC Chapter 7.2 requirements.

Better by design

- Flex and clip installation
- Unique modern design
- Superior aesthetics
- Accurate location starter unit
- Accommodates gutter systems
- Mechanical fixing
- Ideal for new build and quality refurbishment
- Batten gauge range: 260 - 355mm
- Roof pitch range: 15 - 55°
- BBA tested to BS 5534 and BS 8612 requirements
- Manufactured under BS EN ISO 9001 Quality Management System and BS EN ISO 14001 Environmental Management System
- 10 year performance guarantee

Please visit www.dryvergesystems.co.uk for details.

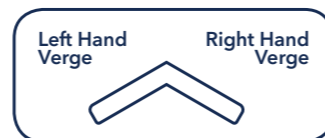
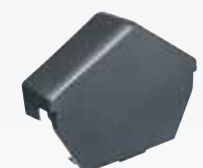

Available Colours

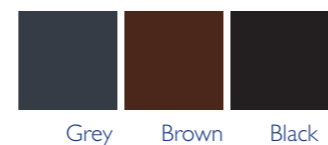

FEEL THE GREAT OUTDOORS

The NatureClad collection is the ultimate wood effect cladding system with a natural look and feel.

Available in 5 textured woodgrain shades, both in 300mm Double Shiplap and 270mm Double Feather Edge cladding profiles.

- High definition woodgrain texture
- Super-matt finish
- Durable and easy to clean
- Lightweight cellular PVC
- Simple to install
- Available in 5 contemporary wood tones
- Trims and joints available in matching wood tones

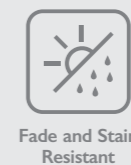
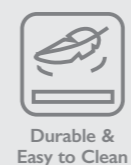
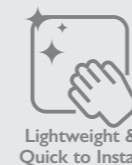

NatureClad Colour Range

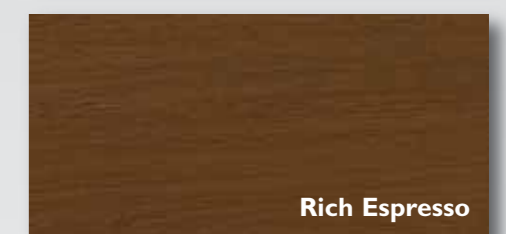

Swish Cladding Versatile Designs

Cellular PVC cladding can be fitted in a variety of patterns including horizontal, herring-bone or diagonal. Some profiles can be mounted vertically.

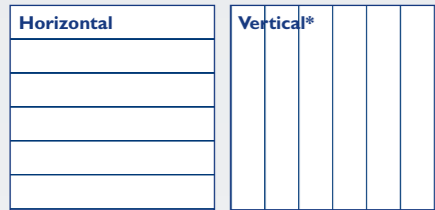

* Tee Gee and Open V only

M-Boss Cladding

Swish M-Boss cladding profiles provide a traditional timber appearance with the practical, low maintenance benefits of cellular PVC. The Shiplap and Feather Edge profiles are available in White, Cream, Sand, Light Grey and Light Blue with a range of matching trims.

Available Colours

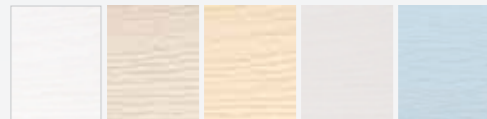

White Cream Sand Light Grey Light Blue

Swish provide a **20 year** Product Guarantee on White M-Boss profiles and a **15/5 year** Product Performance/Colour fastness Guarantee on M-Boss coloured profiles.



Swish Cladding Systems

White

Cellular PVC cladding can significantly improve the thermal properties of a building and provides an excellent low maintenance alternative to timber. The Swish cladding system offers excellent colourfastness and considerable design choice.



Foiled

Cladding profiles are commonly used on the cheeks and apex of dormer windows, as a long life replacement for softwood claddings and as a ceiling soffit for large open porches. The Foiled range is compatible with many window and conservatory system colours, and features colour matched trims and joints.



Design Criteria

White Cladding

Battens: Min. 19 x 38mm.
Recommended 25 x 38mm (suits return flange on C027 starter trim and C040 universal channel with batten cover).

Airspace: Minimum 19mm. Recommended 25mm, with ventilation.

Fixing Centres: 600mm max. up to 2 storeys
400mm max. from 2 to 3 storeys
300mm max for 300mm plank.

Coloured & Foiled Cladding

Battens: Min. 50 x 38mm

Airspace: Min. 50mm to the rear of the installation. Continuity *of the ventilation path should be achieved by omitting the starter batten and by venting into the eaves or leaving a 10mm air gap between the cladding and soffit. Angle ventilators C061 or C065 can be installed at the base and top of the installation to prevent insect ingress.

Fixing Centres: 400mm max.

Note: Designed for use up to 3 storeys (18m max) and 1m from boundaries. Foiled and coloured PVC installations can suffer from excessive expansion and contraction due to heat absorption. Specifiers and installers MUST therefore satisfy themselves that sufficient provision has been made to avoid significant thermal movement with the introduction of adequate ventilation behind the installation.

Generally

Fixings: 25mm A4 stainless steel pins (C203) for 19mm battens.
30mm A4 stainless steel pins (C204) for 25mm battens.

Breather membrane:- Install over timber frame or in exposed locations.

Insulation incorporated:- Counter batten and include breather membrane. 25mm ventilated airspace must be provided for white, coloured and foiled cladding as above.

Sealing: Use low modulus silicone (C077).

Available Colours

Shiplap (150mm) and Open V (100mm) cladding profiles are available in Mahogany, Light Oak, Rosewood, Anthracite Grey and Black.

Shiplap (150mm) is additionally available in Agate Grey (RAL 7038).

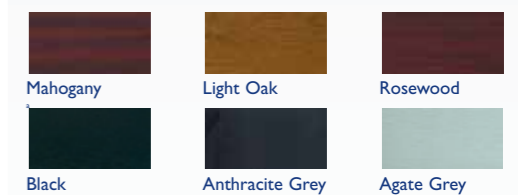

Product Guarantees All Swish White cellular PVC profiles carry a **20 year** Product Guarantee. All foiled and coloured cellular profiles carry a **10 year** Guarantee.

Ventilation

Over Fascia Ventilator



Over Fascia Ventilation

Where a 'clean' soffit is required use an Over Fascia Ventilator or a Vented Eaves Protector, fixed securely to the top of the fascia board. The Vented Eaves Protector eradicates 'ponding' which may occur behind the fascia board where the sarking felt can sag. This provides a continuous 10mm air path.

Through Fascia Ventilation

Polo™ ventilated soffit boards provide the equivalent of a continuous 10mm or 25mm air path as required.

Strip ventilators allow additional or alternative means of ventilation to the roof void. These are designed to fit Swish 9mm GeePee™ soffits and are available in both 10mm and 25mm configurations.



Vented Eaves Protector



Tudor Board

Swish foiled Tudor Board may be used to create low maintenance timber effects to gable ends and dormers.

Tudor Board profiles should be fixed with 2 x 65mm capped screws at minimum of 400mm fixing centres into a suitable, secure substrate.

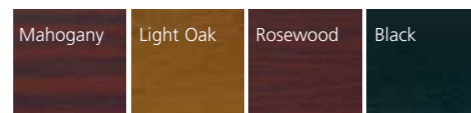

PVC Sustainable Rainwater Systems

Swish Rainwater Systems are ideal for those who wish to specify quality products that have a reduced carbon footprint. They are unique in the UK in that they contain a high proportion of post consumer recycled PVC.

Approximately 84% by weight of gutters and pipes is composed of recycled material that is derived from old PVC windows and gutter systems that have been removed from buildings when being refurbished or demolished.

The production of PVC components from recycled material requires a fraction of the energy needed to manufacture virgin PVC and so 70% saving in CO₂ output is made during the production of Swish gutter and pipe profiles when compared to production of 100% virgin material.

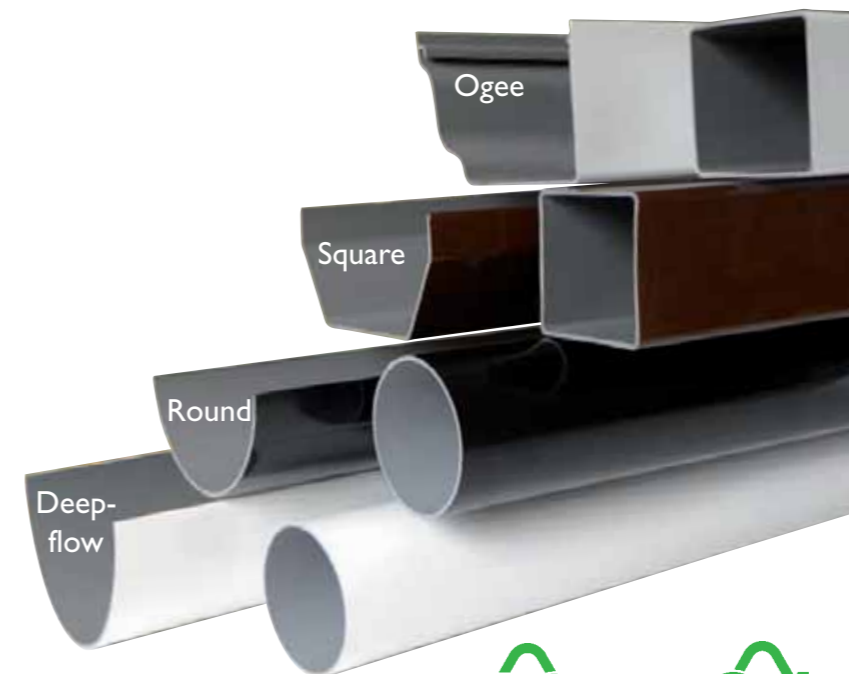

Specification

Performance

Gutter	Flow Rate	Max. area drained
Round	0.9 l/s	43 m ²
Square	1.6 l/s	76 m ²
Ogee	2.2 l/s	105 m ²
Deepflow	1.8 l/s	86 m ²

Colours

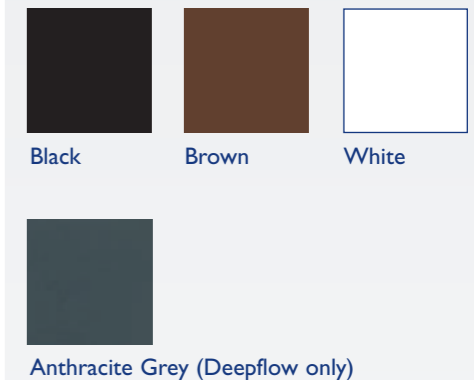

Certification

Swish Rainwater Systems are manufactured to the following standards:-

- Kitemark KM508760
- BS EN 607 : 2004 (Eaves Gutters & Fittings)
- BS EN 12200/1 : 2000 (Plastic Piping Systems)
- BS EN 1462 : 2004 (Brackets for Eaves Gutters)
- ISO 9001 Quality Management System
- ISO 14001 Environmental Management
- ISO 45001 Occupational Health and Safety Management
- ISO 50001 Energy Management



The Finishing Touches

The Swish Technical Support team have developed a number of detailing features that allow the designer to achieve an attractive and individual look without sacrificing the benefits of a standardised system.

Decorative Roofline

The decorative edge of these Concave and Convex profiles offers flexibility of design, particularly where the two boards join at the apex. These 16mm thick boards are available in standard 5m lengths and can be fixed direct to rafter ends with no requirement for additional backing timber.



Bespoke designs are possible subject to volume requirements. For further information please contact the Swish Technical Services Team.

Roofstyle

Swish Roofstyle moulded components can be fitted to the face of a bargeboard or to the first rafter. Joints between components self-align and fixings are hidden to enhance appearance. The system includes Concave and Convex clip-together components.



Swish Decorative Elements

Bargeboards, Spires and Finials

These profiles add traditional character to any building. They combine the high performance, low maintenance characteristics of PVC with lasting good looks and are ideal for both new build and refurbishment projects.

Convex



Concave



Ball Finial & Bracing Bar



Roof Spires - 3 designs



Enhancing the Installation

Swish offers a range of trim profiles that can be used to enhance the look of the installation. A small selection is featured here. Typical applications are at the gable eaves and under the fascia/soffit.

Scotia



Rectangle

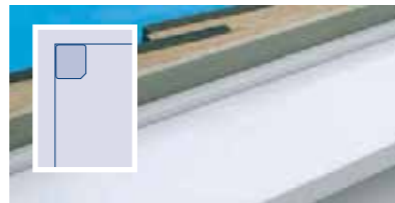

Quadrant

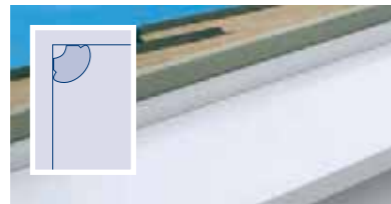

Scotia & 'D' Mould



Roofstyle Components

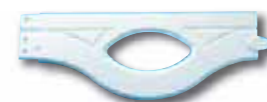

C446 - Convex

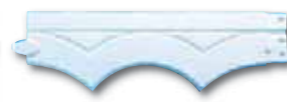

C445 - Concave

Dentils

Decorative Dentil mouldings add elegance to the eaves of any property, creating individual architectural detailing. The range includes a choice of 3 sizes, and differing designs.



- A strong mechanical secret fix is achieved through the soffit using stainless steel screws.
- Alternatively the timber fixing plate may be detached and screwed to the soffit or wall.

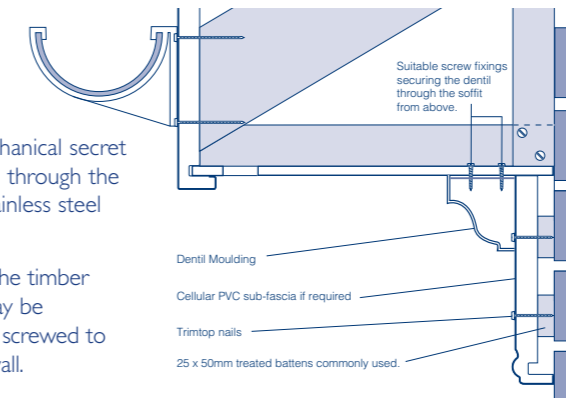

Gallows

Swish Gallows Brackets are load bearing to an end loading capacity of 75kg per gallow and capable of offering structural support to door and window canopies. The surface pattern mimics the traditional appearance of timber with a high level of bevelling detail.



Dentils

Swish Dentils provide an excellent means of adding both decoration and value to a property.

The range meets the requirements of most new build and refurbishment applications. Each unit is capable of a secret mechanical fix in at least one direction through a built in footplate.

The orientation and spacing are worth careful consideration in order to achieve the best effect. In addition, a continuous sub-fascia of cellular PVC fixed to the wall under the soffit will greatly enhance the effect.

Gallows

Swish exterior Gallows Brackets offer a stylish yet durable details to feature under canopies, bay and oriel windows.

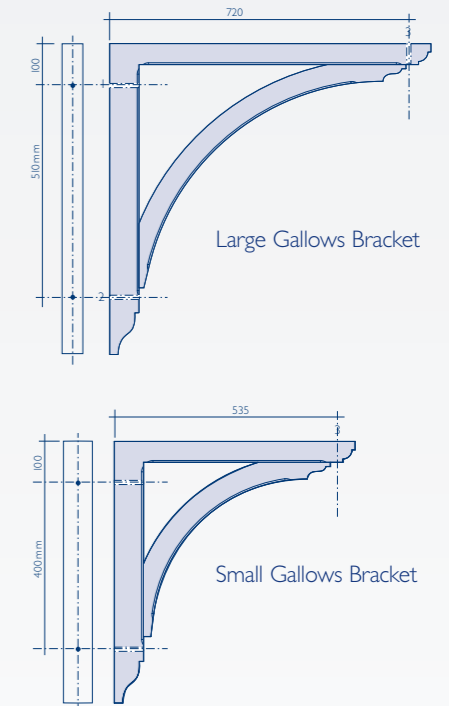

For further details contact:

Swish[®]
BUILDING PRODUCTS

Pioneer House, Mariner, Lichfield Road Industrial Estate, Tamworth,
Staffordshire B79 7TF

Telephone: (01827) 317200

Fax: (01827) 317201

e-mail: marketing@swishbp.co.uk

www.swishbp.co.uk

Swish, Tee Gee, Polo, Jumbo, Jumbotec, M-Boss and NatureClad
are all registered trademarks